

# ColorWash 1200E<sup>AT</sup>

## Photometric Diagrams

### FRESNEL LENS

Lamp: MSR 1200 SA

Beam angle 10° - LightMax Mode

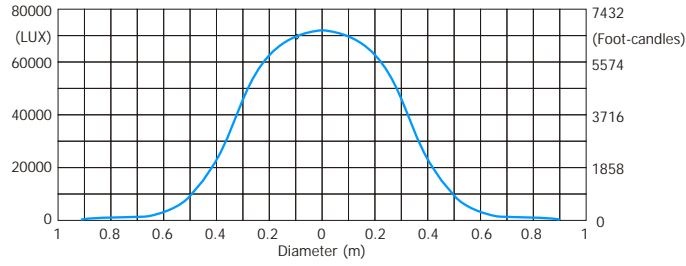
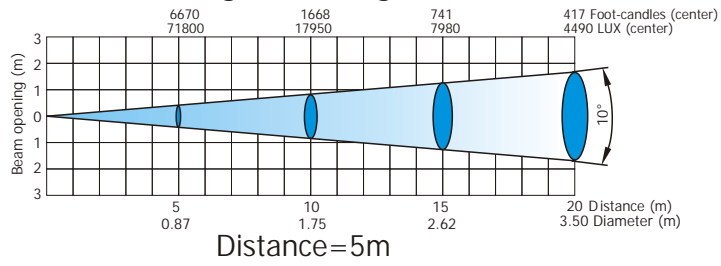

Beam angle 13° - Min. zoom

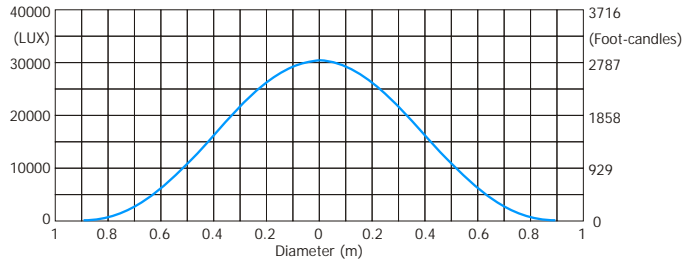
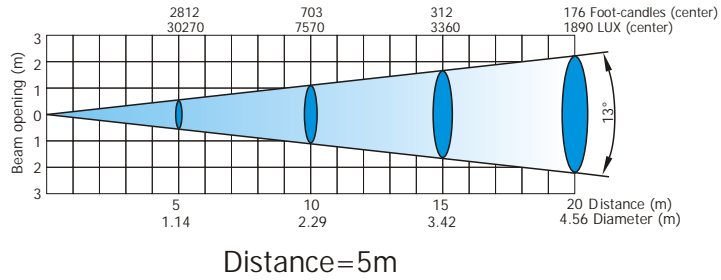

Beam angle 44° - Max. Zoom

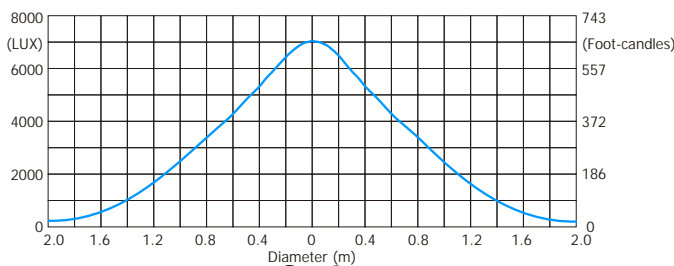
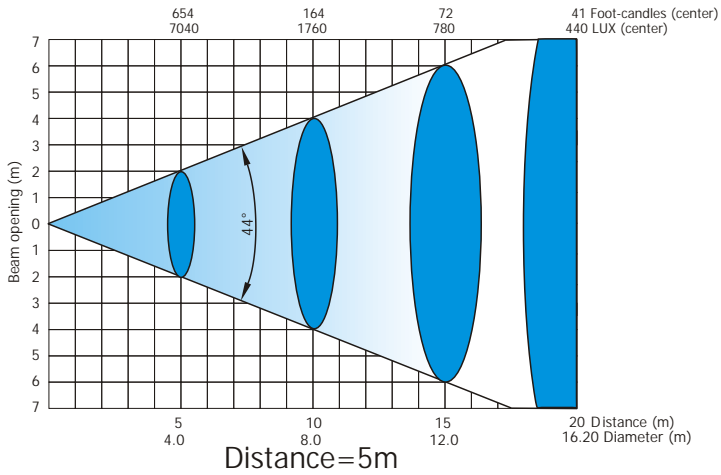

# ColorWash 1200E<sup>AT</sup>

## Photometric Diagrams

### WIDE-ANGLE LENS

Lamp: MSR 1200 SA

Beam angle 68° - Lightmax.mode

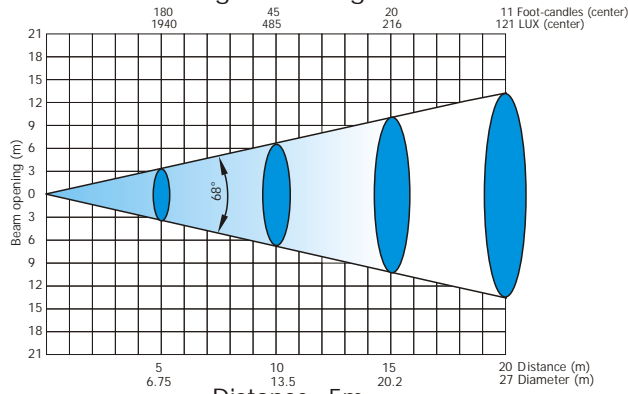

Distance=5m

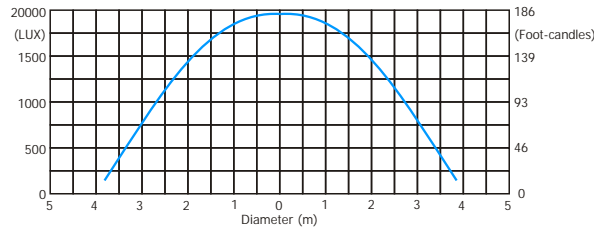

Beam angle 75° - Min. Zoom

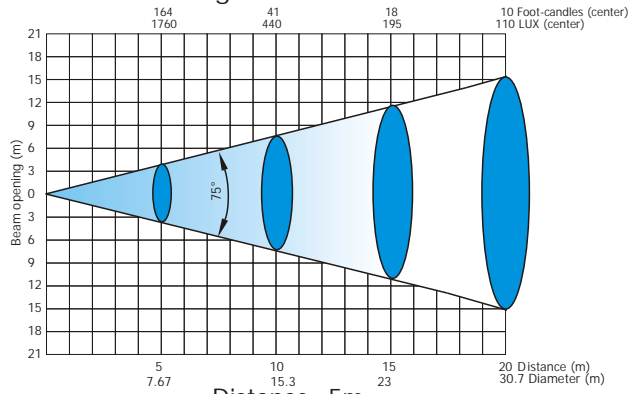

Distance=5m

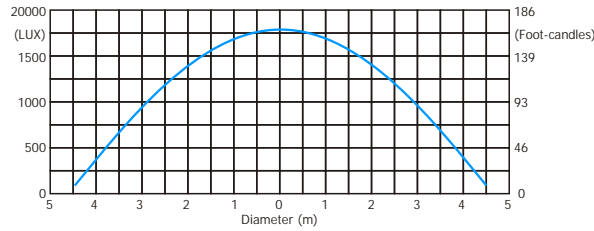

Beam angle 87° - Max. Zoom

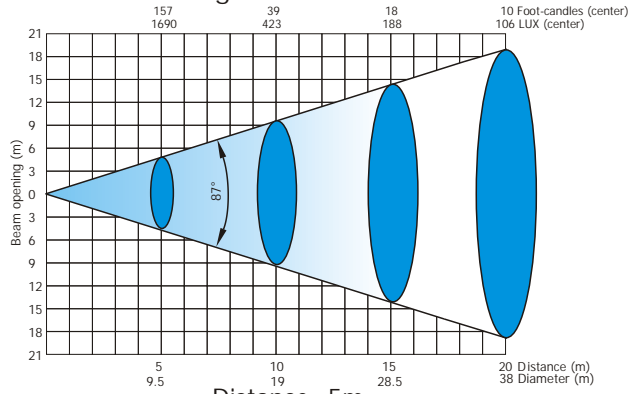

Distance=5m

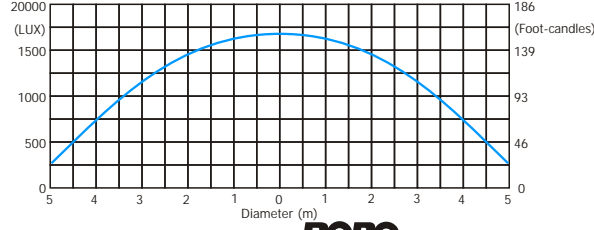

# ColorWash 1200E<sup>AT</sup>

## Photometric Diagrams

### PC LENS

Lamp: MSR 1200 SA

Beam angle 10° - LightMax mode

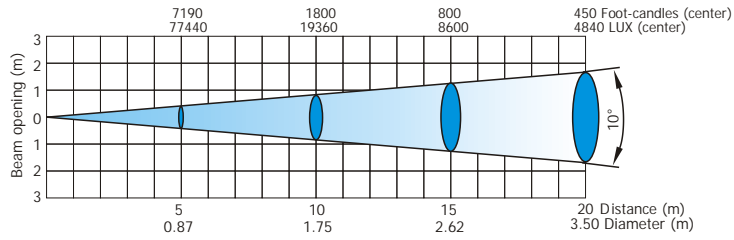

Distance=5m

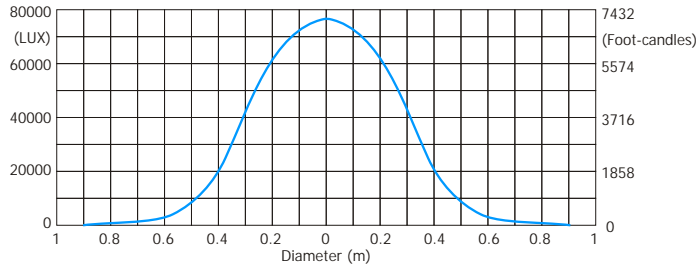

Beam angle 12° - Min. zoom

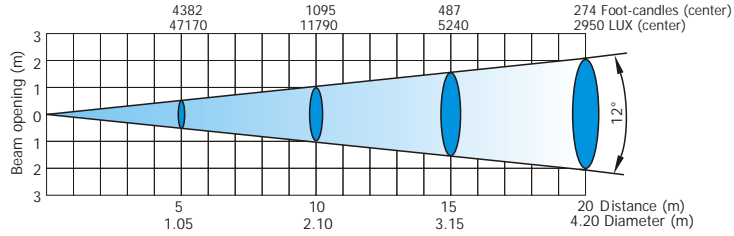

Distance=5m

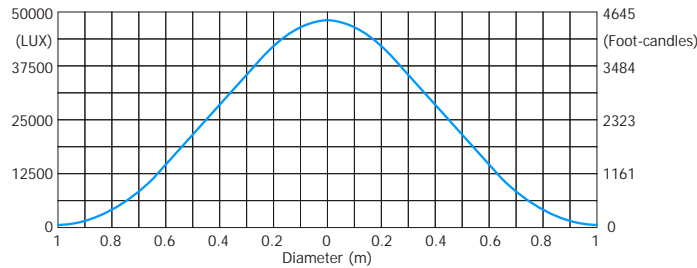

Beam angle 36° - Max. Zoom

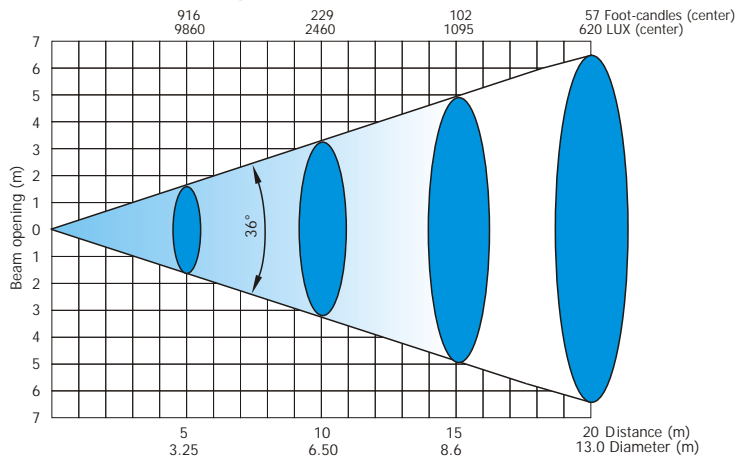

Distance=5m

