

VL3015LT Spot

l u m i n a i r e



The VARI**LITE* VL3015LT Spot Luminaire provides the increased output of a 1500W lamp in a luminaire that offers an incredible zoom range optimized for long throw applications along with a vast array of powerful features.

The VARI**LITE* VL3015LT Spot luminaire features 10:1 zoom optics, CYM color mixing, variable CTO wheel, two five-position color wheels, three gobo/effects wheels, a beam size iris, and separate dimmer and ultra-fast strobe mechanisms. A standard palette of gobos, effects and colors is provided with the unit. Custom gobos, effects, and colors are available.

Additionally, the light contains an independent rotating and indexing 3-facet prism as well as an independent variable frost glass. The zoom range of 6° to 60° allows for use in a multitude of applications from stadiums to theatres.

The VL3015LT spot luminaire allows users to operate its single lamp at three different wattages via either a control channel setting or a lamp menu option. With only a setting adjustment, the fixture will run its short arc lamp at 900W, 1200W or 1650W without any detrimental effects on the lamp.

An upper enclosure houses the control electronics as well as the arc power supply for the 1500 watt short arc lamp. The arc power supply is power factor corrected for efficient power distribution. New, oversized upper-enclosure handles allow for easier hanging and loading.

The VL3015LT Spot luminaire can be controlled from a wide variety of DMX512 consoles.



Programmable Functions

Color System:	Six color control wheels total. A three filter CYM cross fading system, two fixed color wheels with five interchangeable color filters each capable of continuous wheel rotation for additional effects, and a variable CTO color temperature correction wheel.
Zoom Optics:	A 13-element 10:1 zoom optics system, covering a range from 6° to 60°.
Beam Size Control:	A mechanical iris provides continuous beam size control for rapid and smooth timed beam angle changes.
Intensity Control:	Full field dimming designed for smooth timed fades as well as quick dimming effects.
Strobe:	High-performance dual blade strobe system capable of ultra-fast operation.
Rotating Gobo Wheels:	Three gobo/effects wheels combine to each offer four rotatable, indexable gobo positions and one open position.
Edge and Pattern Focus:	Variable beam focus to soften edges of gobos or spots. Remarkable depth of field capability allows morphing effects between all pattern and effects wheels.
Frost & Prism Capability:	Independent rotating and indexing 3-facet prism as well as an independent variable frost glass.
Pan and Tilt:	Smooth, time-controlled continuous motion by way of three-phase stepper motor systems.
Range:	Pan - 540°, Tilt - 270°.
Accuracy:	0.3° resolution.

Description

Source:	Triple wattage, double-ended lamp. The lamp is capable of operation at 900W, 1200W or 1650W - mode selectable from fixture or console.
Color Temperature:	6000K at 1650W and 6300K at 900W and 1200W
Fixture Output:	41,487 lumens
Power Requirements:	Standard AC power distribution from 200– 264 VAC, 50/60 HZ. The unit requires up to 12A depending on the AC supply voltage.
Reflector:	Precision glass reflector system with dichroic cold mirror coating.
Operational Temperature:	-20° to 104°F (-29° to 40°C).
Cooling:	Forced air cooling.
Control:	Completely compatible with a wide variety of DMX512 consoles.
DMX Channels:	36
Mounting Position:	The VL3015LT Spot luminaire can be mounted and operated in any orientation.
Spacing:	Hangs on 31 in. (79 cm) centers.
Weight:	115 lbs (52.3 kg).

Ordering Information

Luminaires: 20.9698.0001	VL3015LT Spot Luminaire, Black, Includes 1500W Short Arc Lamp
Accessories: 71.9686.1510 22.9620.0194 28.8500.0054 55.6840.0001 55.6841.0001 PC1BE PC1GTL208 21.9698.9610	1500W Short Arc Lamp Safety Cable Assembly USB Luminaire Programming Kit Truss Hook, Mega-Clamp (For round and square pipe) Truss Hook, Mega-Claw (For 2" round pipe) AC Input Cable, PowerCon with Bare End (no connector), 1 Meter AC Input Cable, PowerCon with Twist Lock (Male), 250V, 1 Meter VL3015LT Followspot Handle (1 Each)

PHILIPS
VARILITE***

VL3015LT Spot

l u m i n a i r e

Specifications

The unit is an integrally designed, remote-controlled, motorized spot luminaire. The head, yoke and enclosure housings are constructed of aluminum alloy for light weight, strength and durability. Low-noise fans provide forced-air cooling for internal components. The rear cap is hinged, providing easy access to the lamp for replacement. Oversized upper-enclosure handles allow for easier hanging and loading.

A single AC input PowerCon connection along with two, five-pin DMX512 compatible connectors (in and through) are provided. The unit can be controlled from a wide variety of DMX512 consoles.

Each unit is equipped with an on-board processor providing diagnostic and self-calibration functions as well as internal test routines and software update capabilities.

The unit contains two independent three-phase stepper motors to provide movement of the head through 540° in the horizontal plane (pan) and 270° in the vertical plane (tilt). The pan and tilt mechanisms are belt-driven, providing positional resolution and repeatability of 0.3° on either axis. Unit shall include integral pan and tilt transport/service locks.

A 10:1 zoom optics system adjusts the projected field angle over a range of 6° to 60°. Variable beam focus is provided to soften the edges of gobos or spots and to provide gobo morphing. The projected image remains in focus throughout the entire zoom range.

The unit contains a CYM color mixing system, as well as variable CTO color temperature correction.

Two color wheels capable of continuously spinning are also included. Each of the two wheels holds five interchangeable dichroic colors to allow for custom configurations. The unit comes equipped with a standard palette of dichroic color filters.

Unit has three, four-position gobo/effects wheels. Each contains individually rotating, indexable gobos and patterned glass effects. The rotating gobos are easily interchangeable to allow customization of the unit. The unit comes equipped with a standard set of gobos and effects. (A wide selection of colored and patterned gobos and effects is available from Vari-Lite.)

A mechanical iris provides continuous beam size control for rapid and smooth timed beam angle changes.

The unit contains a patterned glass dimmer wheel that provides full field dimming and allows for smooth timed fades and fast blackouts.

A dual blade strobe and dousing system provides variable strobe effects capable of rapid operation.

The unit contains an independent rotating and indexing 3-facet prism as well as an independent variable frost glass.

The unit shall be ETL and ETLc certified and CE-marked. Exterior finish is black.

Hanging Dimensions

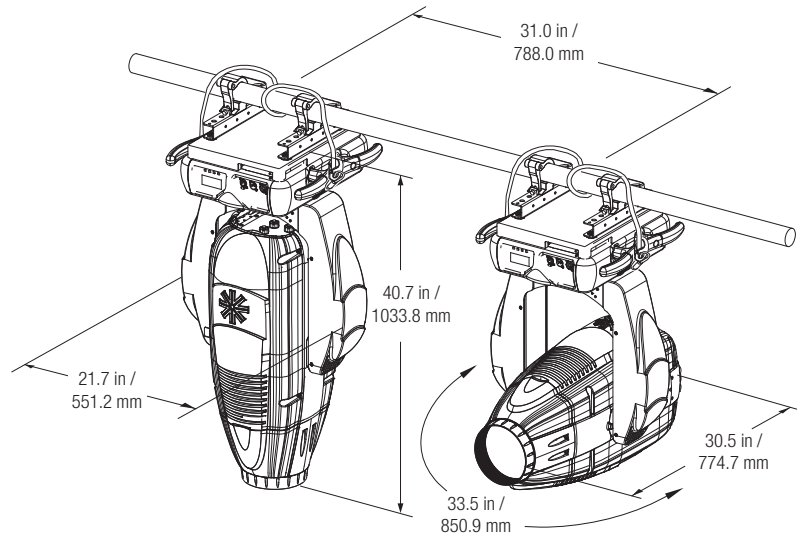

Note: _____
Shown with optional safety cables, clamps, etc.

Photometric Data

VL3015LT Spot Luminaire - 1500W Metal Halide			
Zoom Lens Position	Field Angle (degrees)	Total Lumens	CCT
NFOV	5.6	19,854	6601
MFOV	32.0	41,487	
WFOV	52.1	34,226	

Notes:

All data taken with seasoned light source at 20 hours of life.

Fixture output = 41,487 lumens.

PHILIPS
VARI*LITE

©2015 Philips Group. All rights reserved. Printed in the U.S.A. We reserve the right to change details of design, materials and finishes. Specifications are subject to change without notice. VARI*LITE automated lighting equipment is made in the U.S.A.



Vari-Lite
10911 Petal Street
Dallas, TX 75238
1.877.VARILITE
fax: 214.647.8038
www.vari-lite.com



VL3015LT_Spot - 110115_NA